

Projekti Arkitektonik

MIXUSE
13-24 KATE

Tiranë 2022
Faza e projektit

Projekt Ide

SON

Son Engineering & Construction
Rruga "Derhemi 3" Tiranë

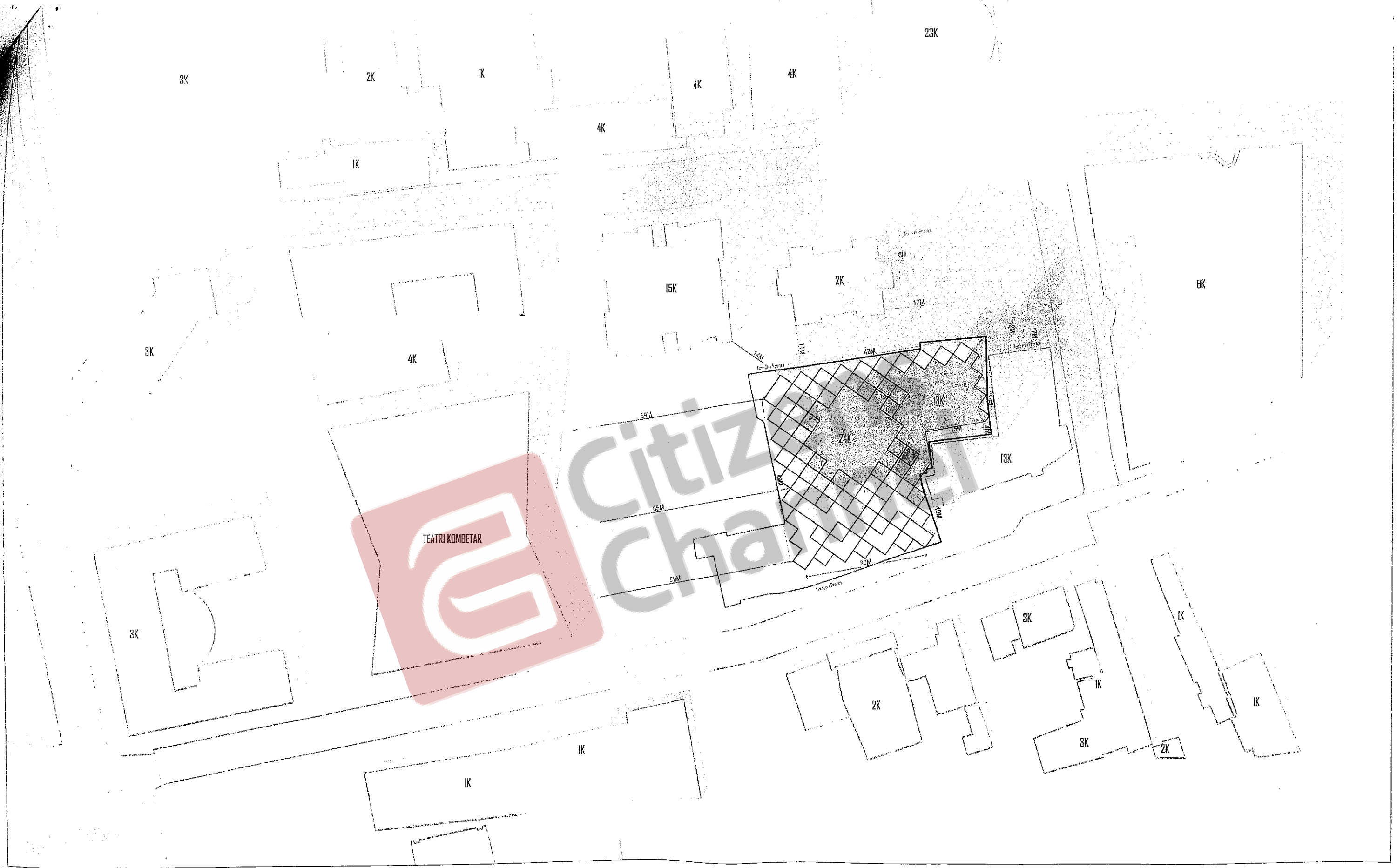
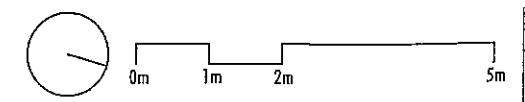
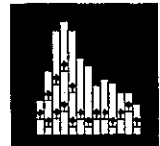

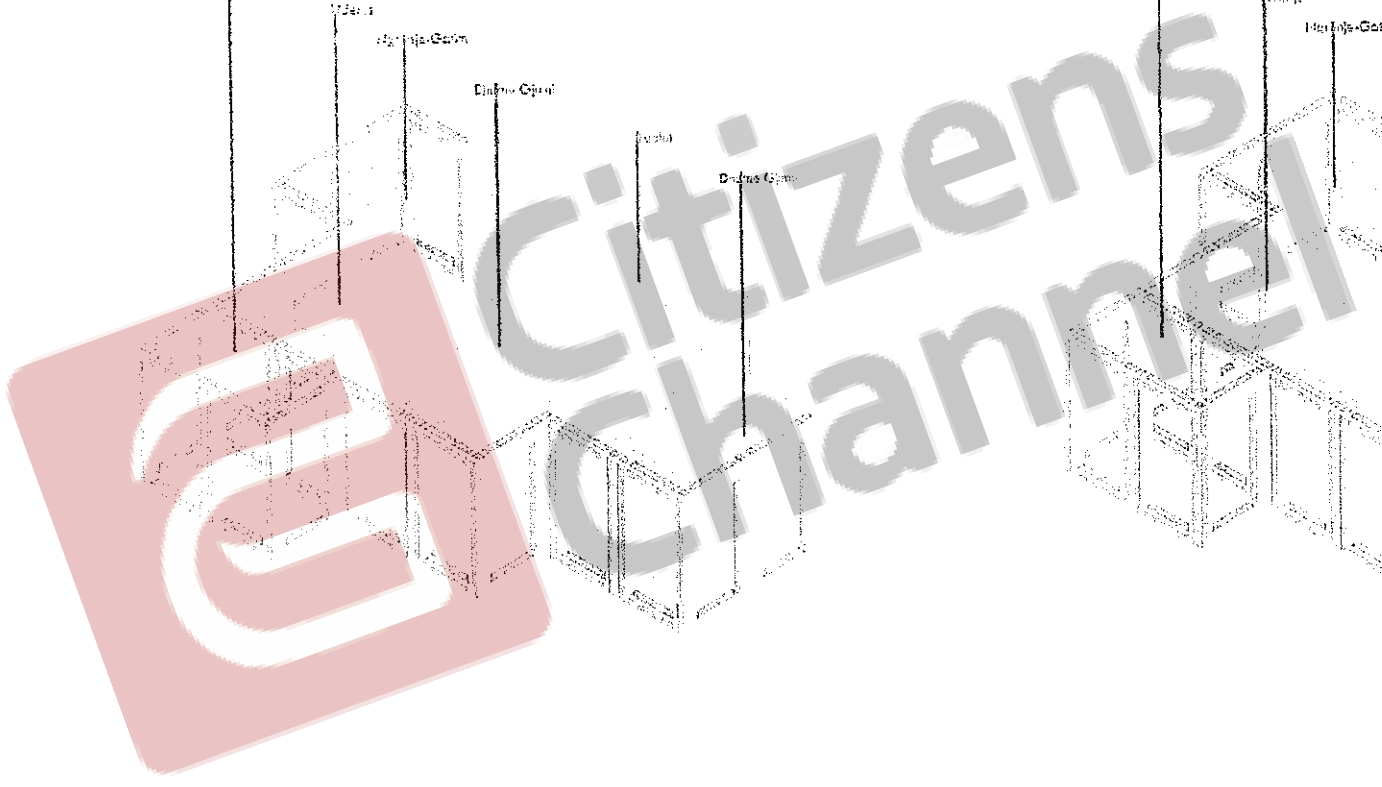
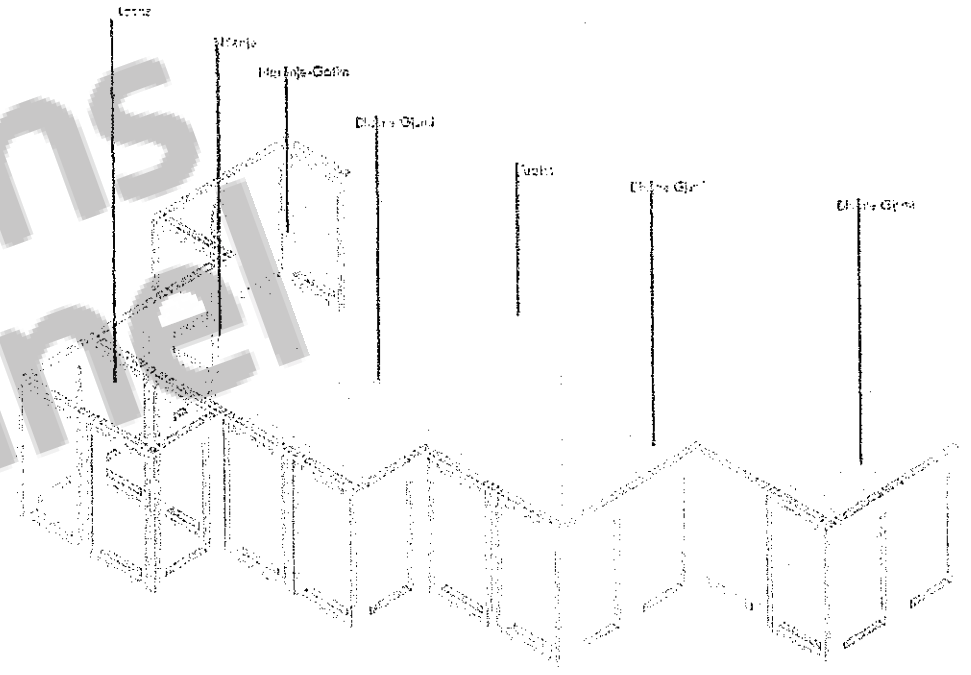
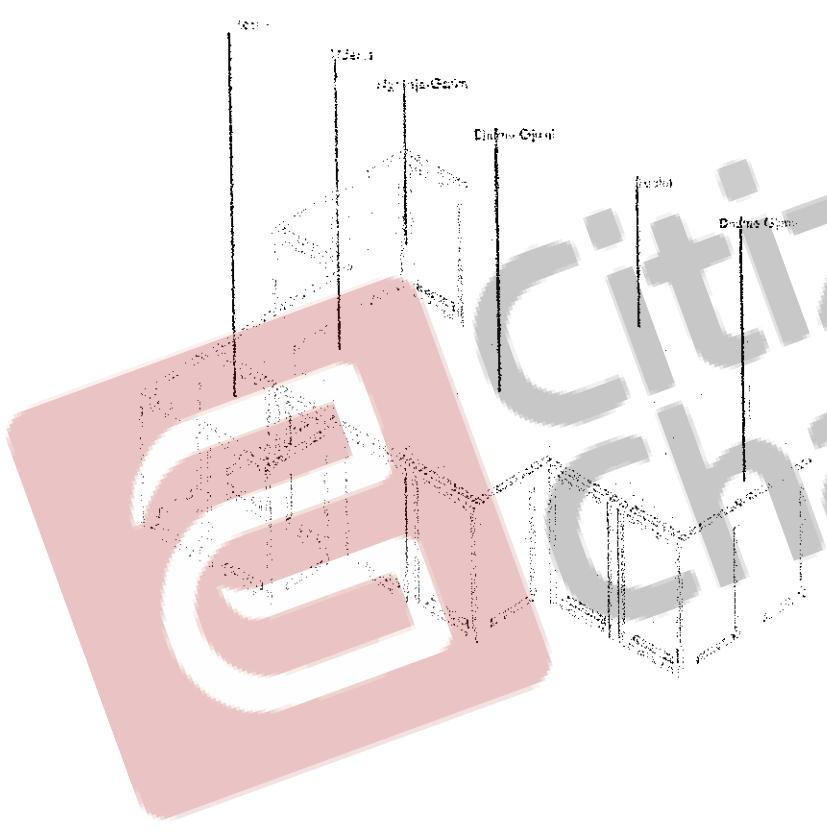
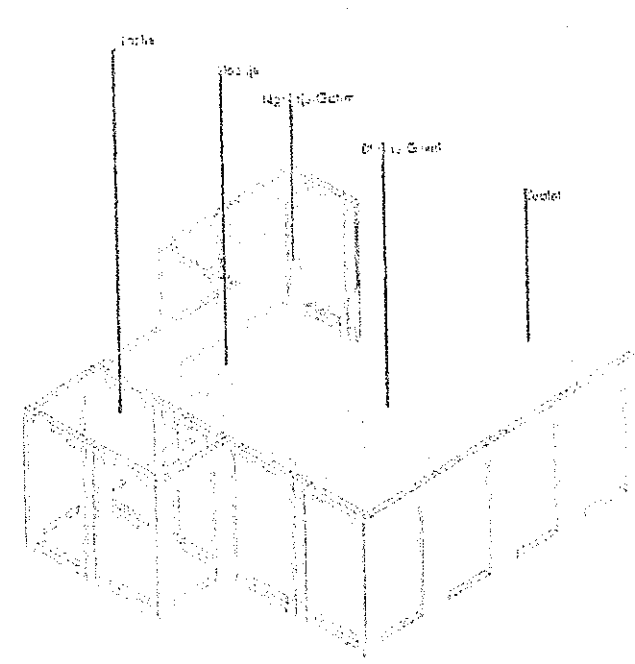
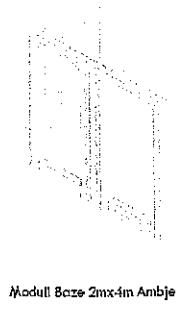
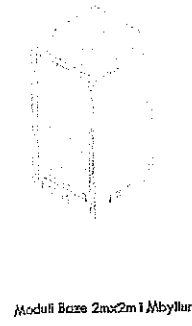
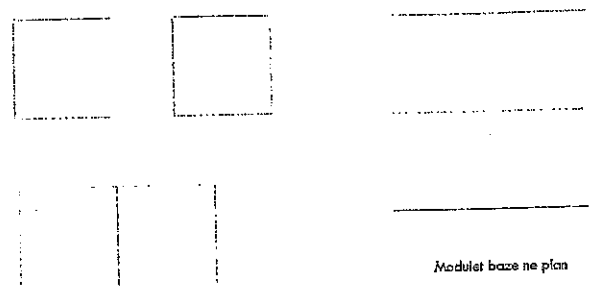

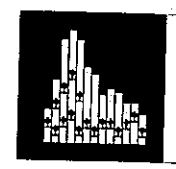
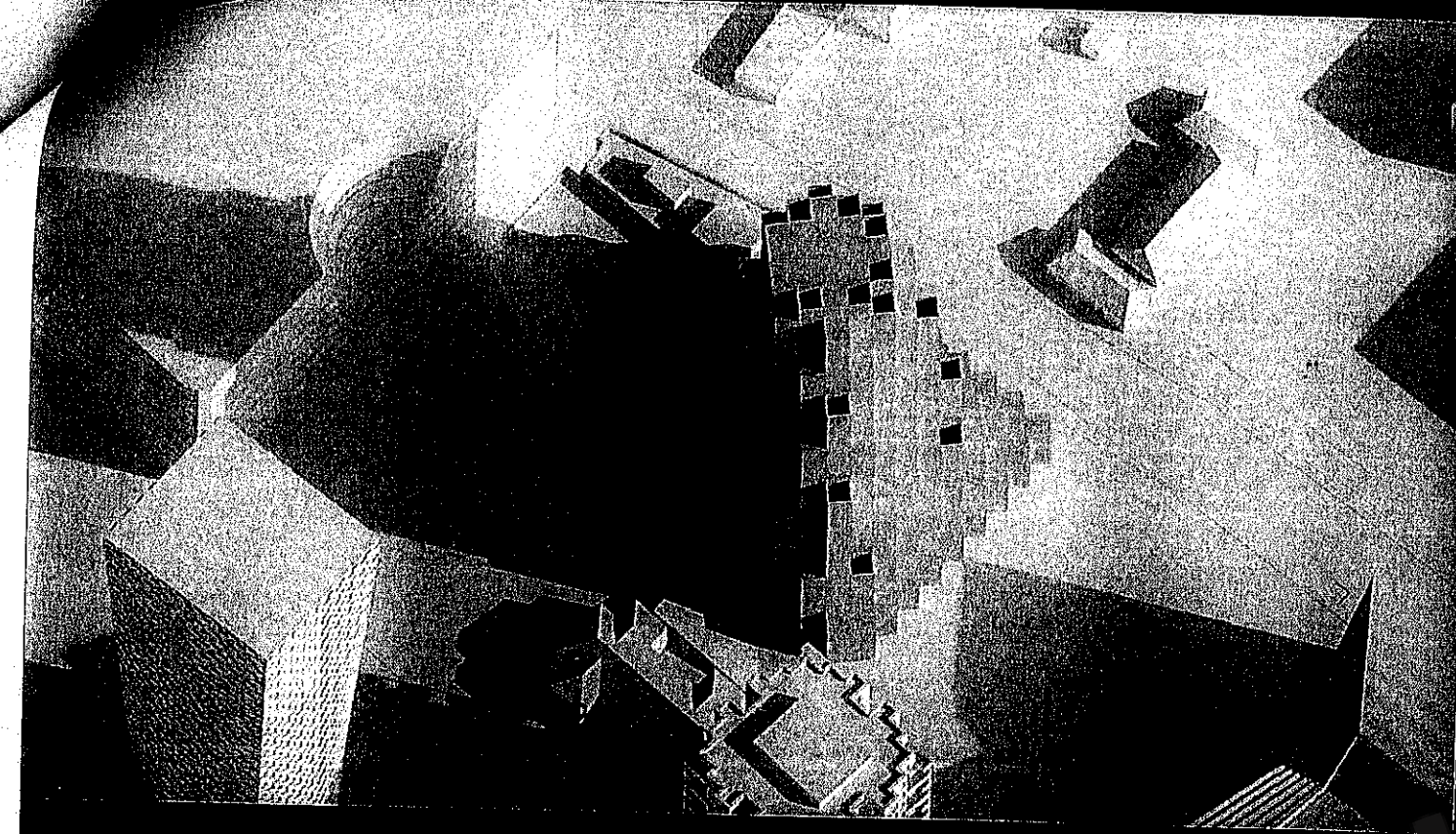

15K

2K

6K

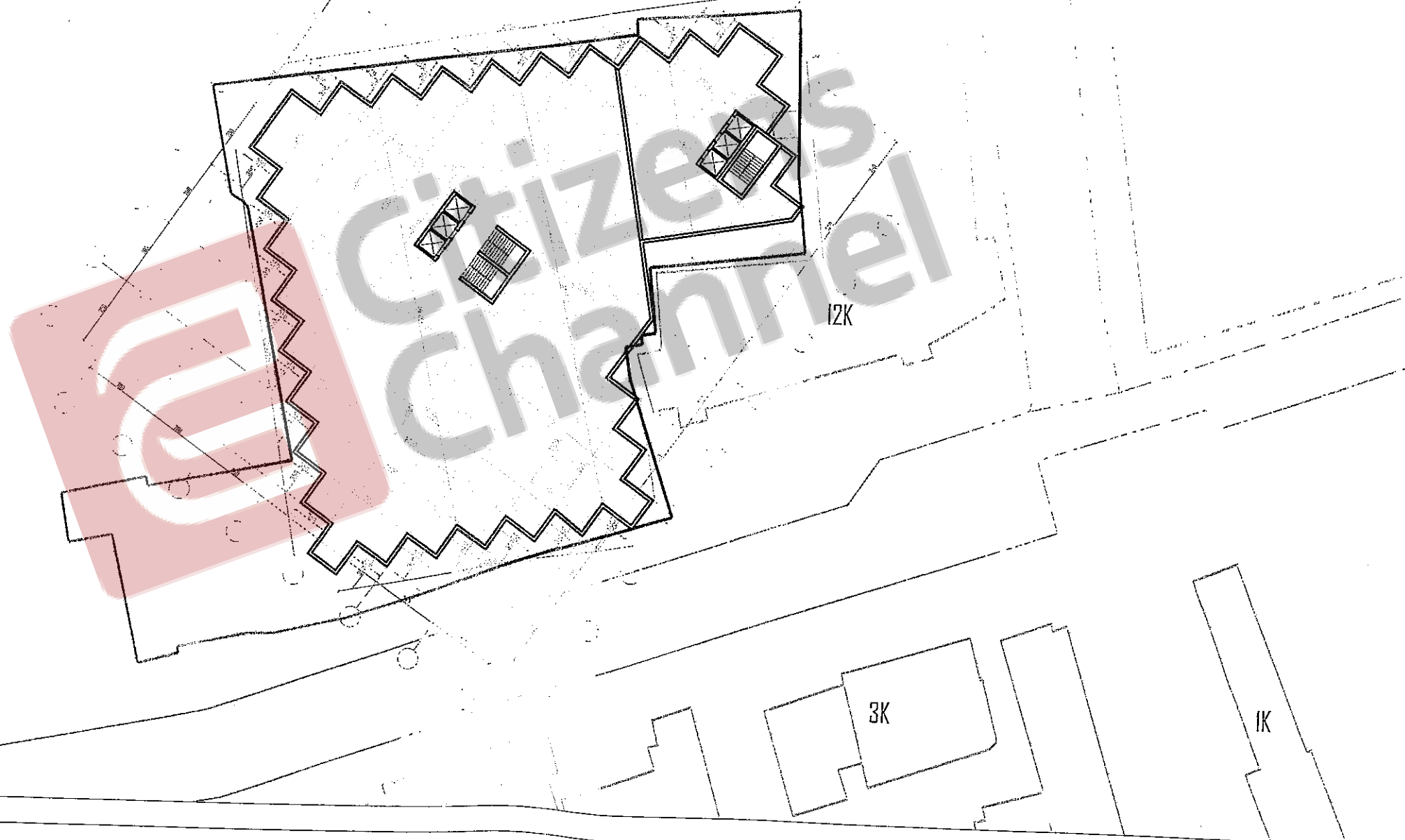

04

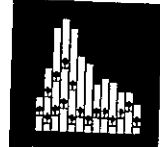

MIXUSE
■ KATI PËRDHE

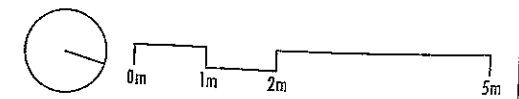

SON
SON Engineering & Constr.

15K

2K

6K

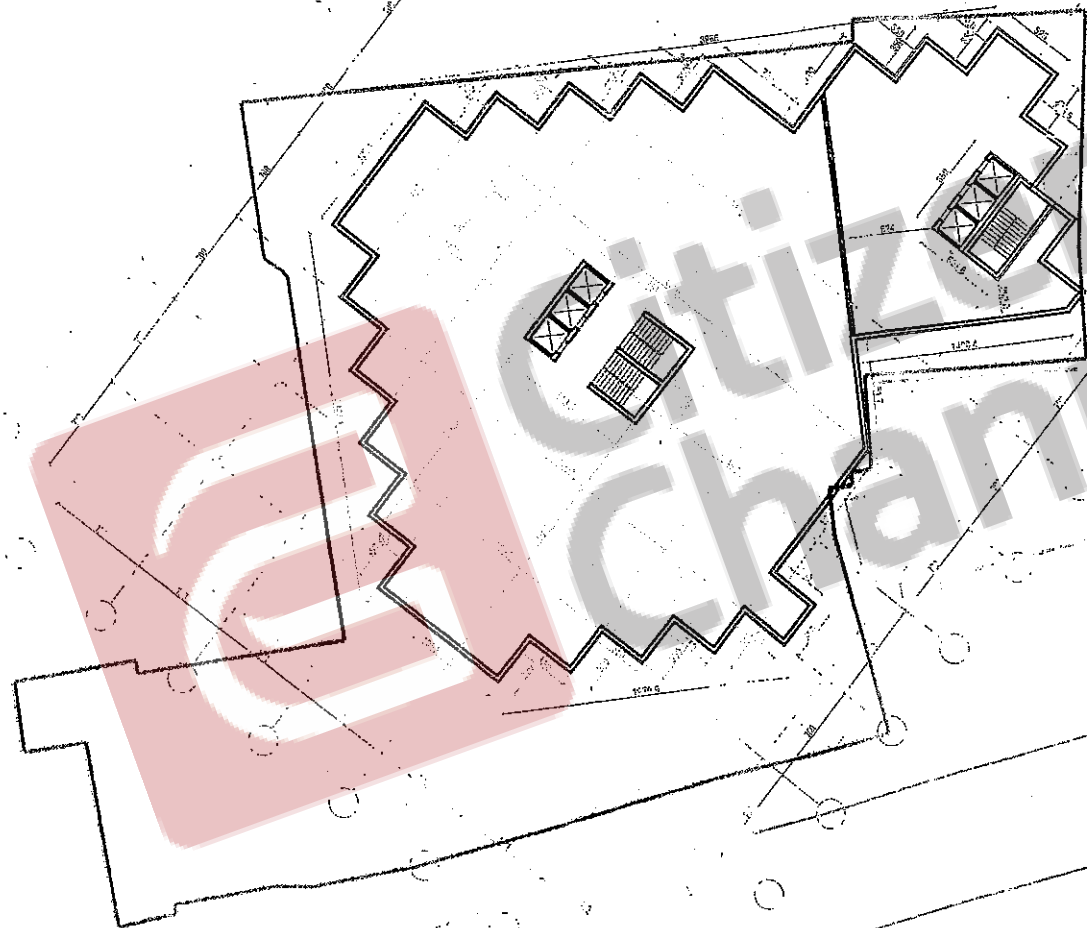

12K

3K

1K

05

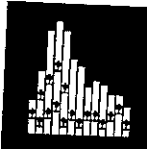

MIXUSE

KATI I KATËRT



0m 1m 2m 5m

SON
SON Engineering & Construction

15K

2K

6K

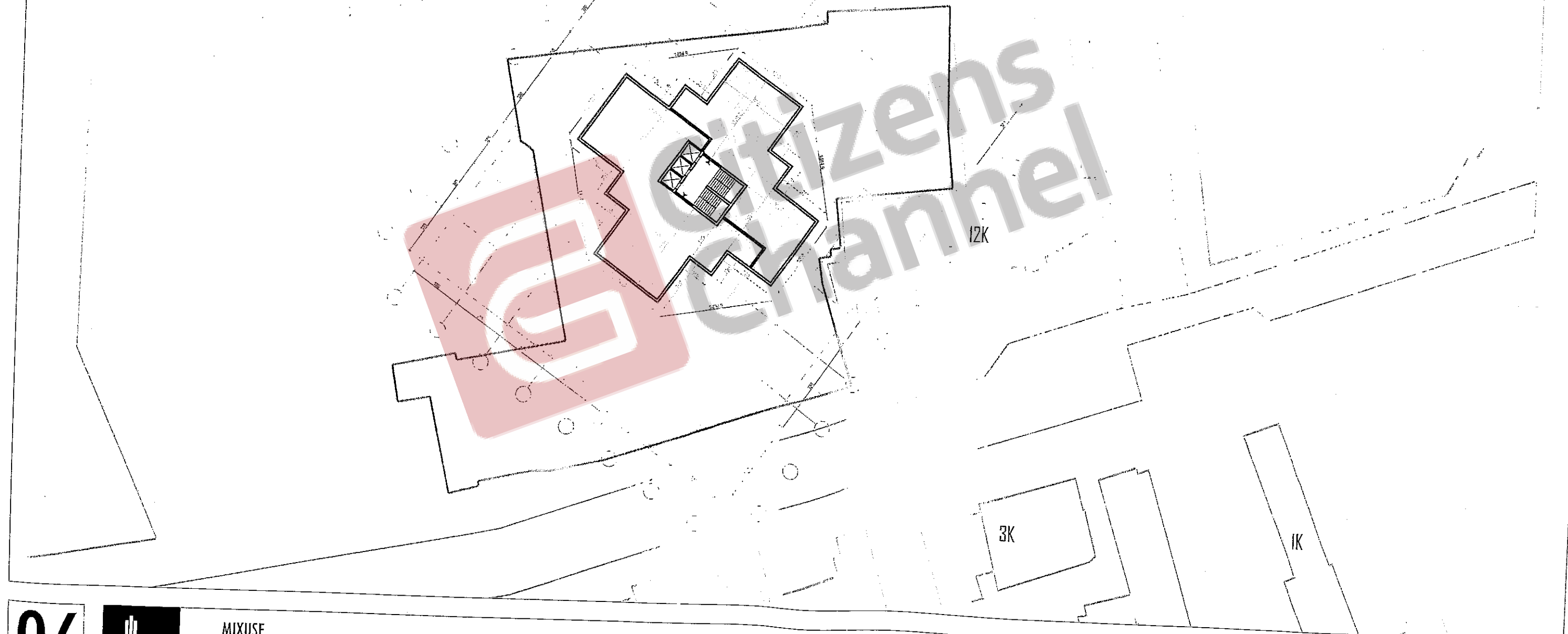

06



MIXUSE
 ■ KATI 13

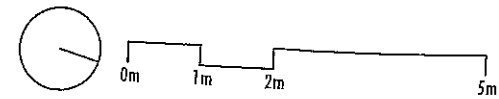

SON
 SON Engineering & Construction

15K

2K

6K

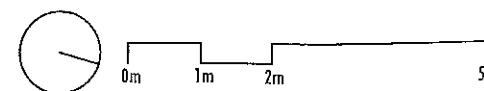
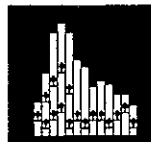
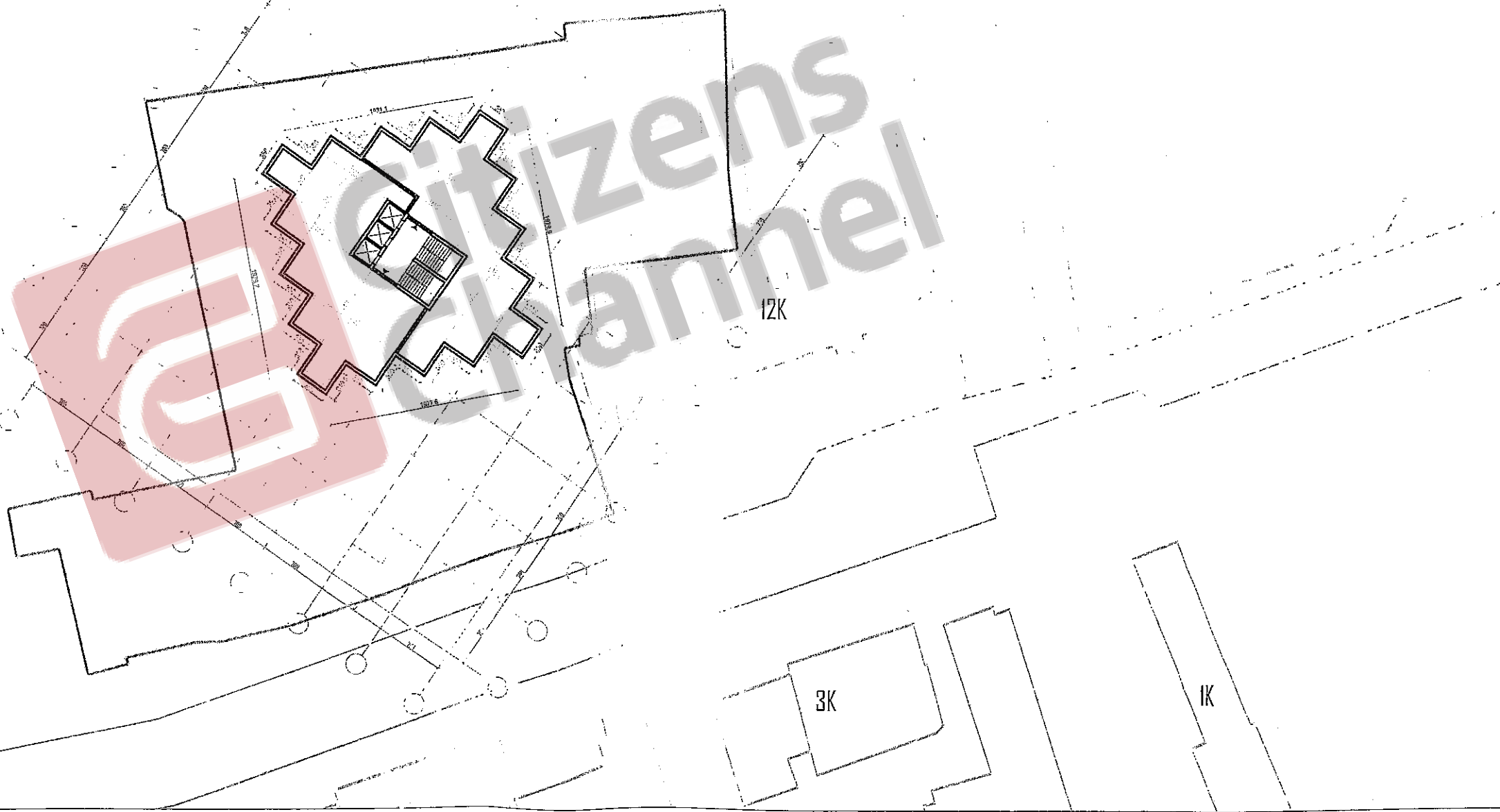

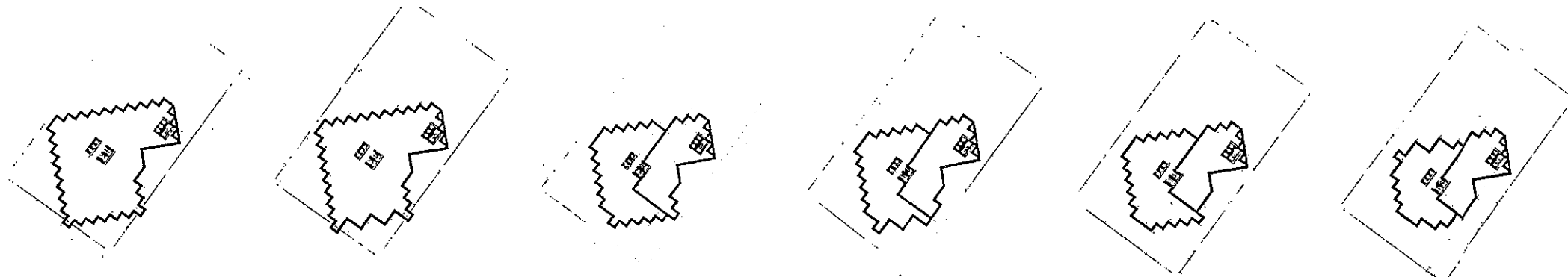

KATI 0 KATI 1 KATI 2 KATI 3 KATI 4 KATI 5

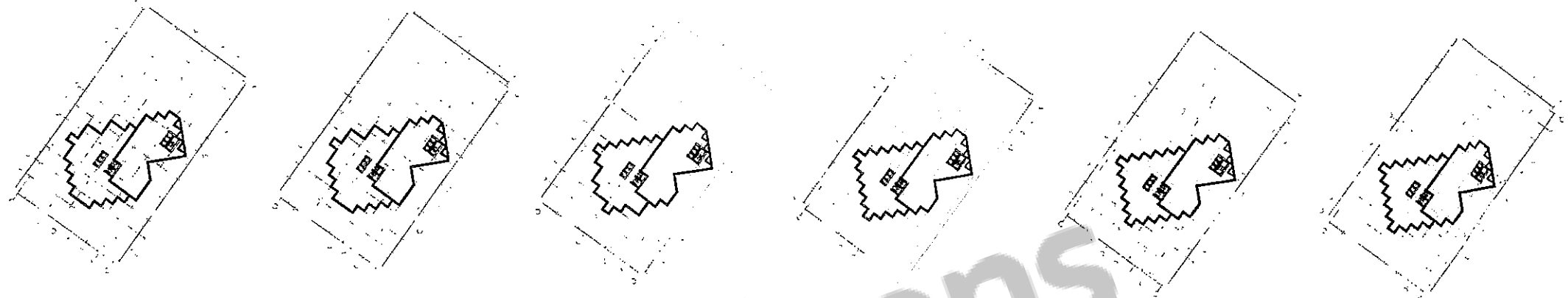

KATI 6 KATI 7 KATI 8 KATI 9 KATI 10 KATI 11



KATI 12 KATI 13 KATI 14 KATI 15 KATI 16 KATI 17

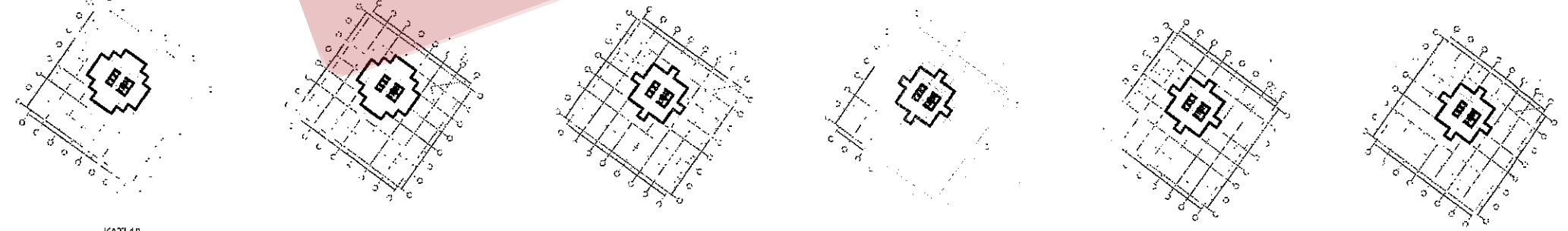

KATI 18 KATI 19 KATI 20 KATI 21 KATI 22 KATI 23

Citizens Channel

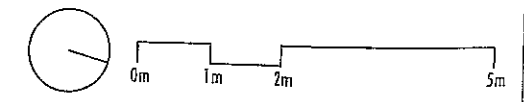
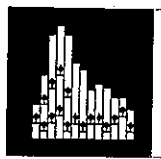
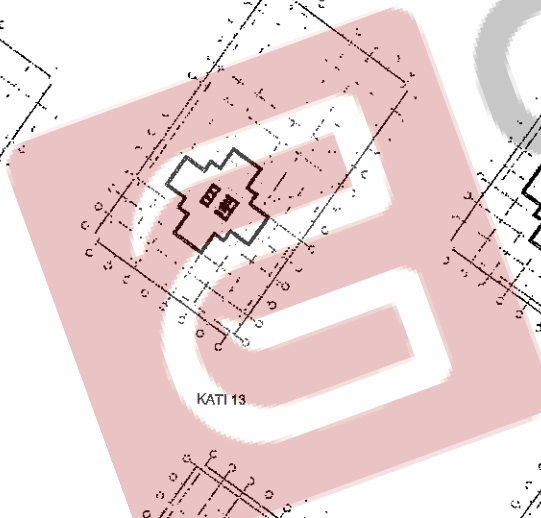



09

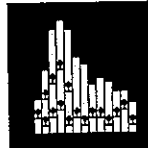

MIXUSE
■ PAMJE AJRORE

SON
SON Engineering & Construction



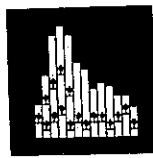
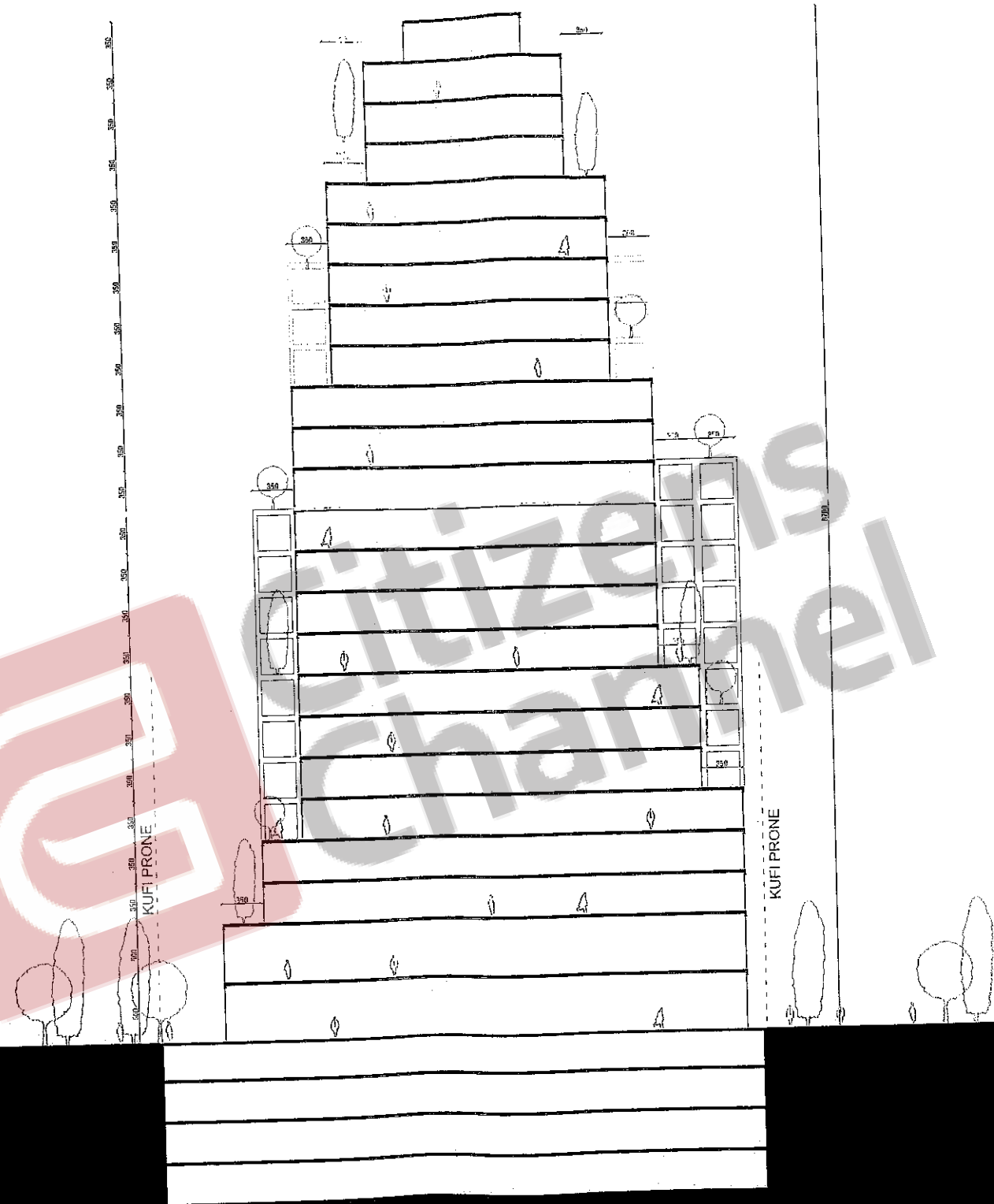



12

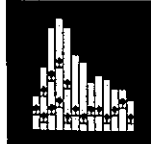

MIXUSE
■ PAMJE

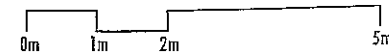

SO
SON Engineering & Con

SON Engineering & Cons



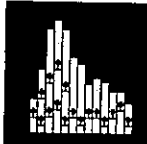
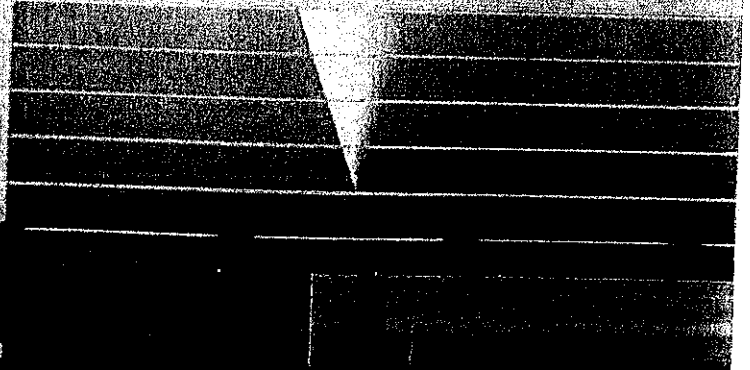
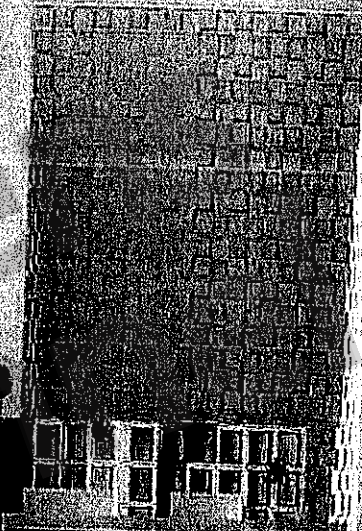
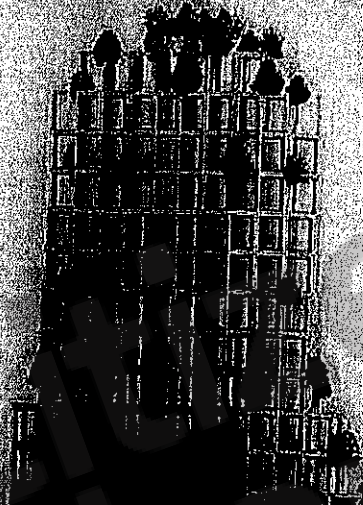
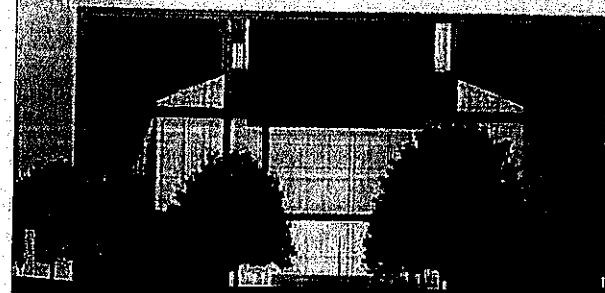



15



MIXUSE
■ VIZUALIZIME

SON
SON Engineering & Cons





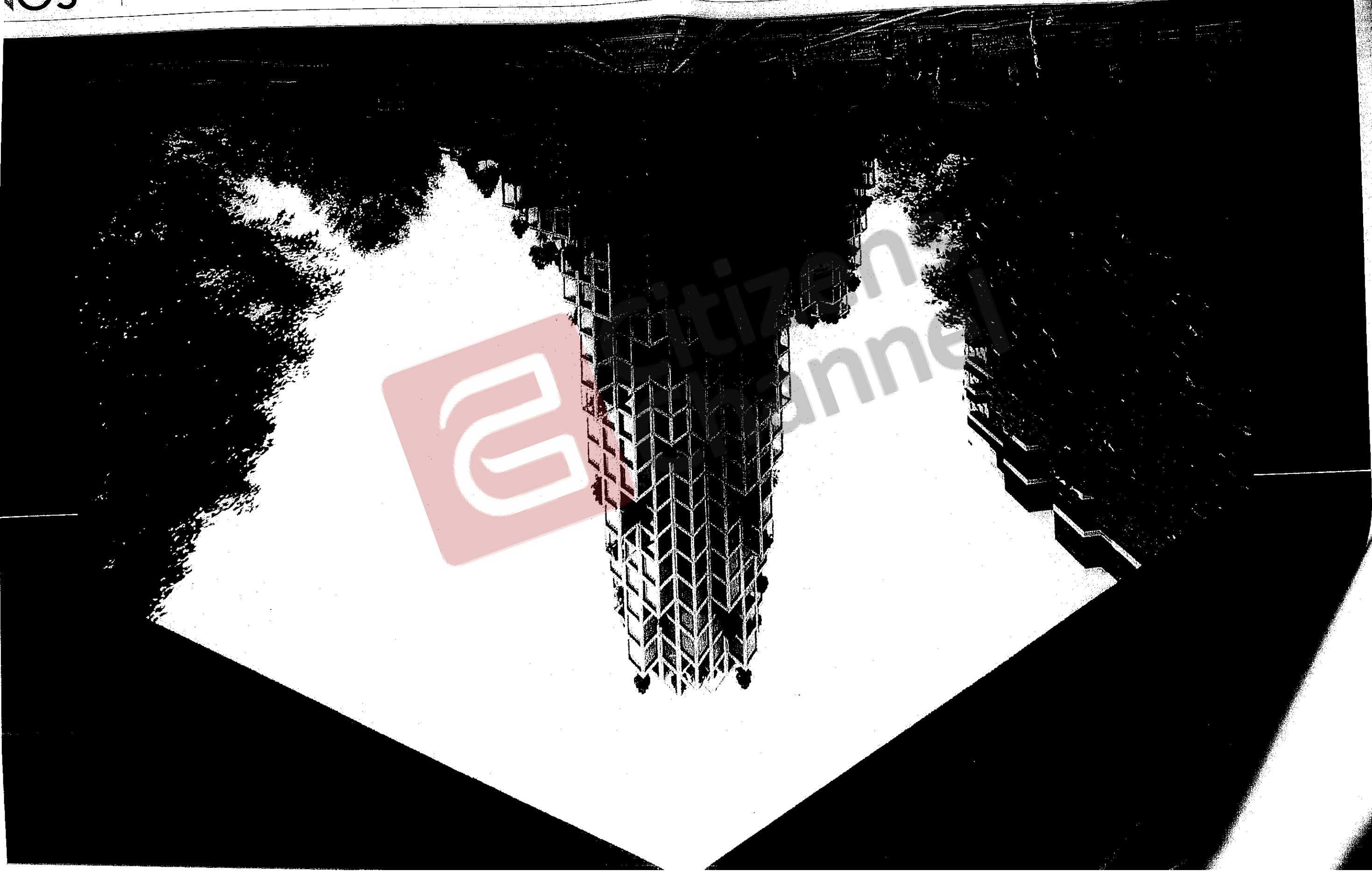





Arzen
Channel

20

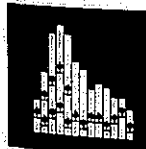

MIXUSE
VIZUALIZIME

SON
SON Engineering & Construction

	Tregtare	Zyra	Banim	Total
Kati 00	1561	254	0	1815
Kati 01	1523	254	0	1777
Kati 02	0	254	1266	1520
Kati 03	0	254	1230	1484
Kati 04	0	254	1181	1435
Kati 05	0	254	1022	1276
Kati 06	0	254	997	1251
Kati 07	0	254	997	1251
Kati 08	0	254	899	1153
Kati 09	0	254	862	1116
Kati 10	0	254	862	1116
Kati 11	0	254	862	1116
Kati 12	0	254	813	1067
Kati 13	0	0	600	600
Kati 14	0	0	600	600
Kati 15	0	0	502	502
Kati 16	0	0	502	502
Kati 17	0	0	502	502
Kati 18	0	0	453	453
Kati 19	0	0	453	453
Kati 20	0	0	355	355
Kati 21	0	0	355	355
Kati 22	0	0	355	355
Kati 23	0	0	355	355
TOTAL	3084	3302	16023	22409

